

User Manual

for Kinetic Wall Switches

CUL 40031 65

CUL 40034 65

CUL 40032 65

CUL 40035 65

CUL 40033 65

CUL 40036 65

A. What is in the box ?

1 Gang:

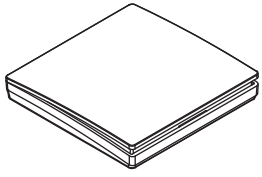

x 1

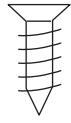

x 2



x 2

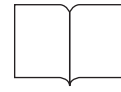

x 1

or 2 Gang:

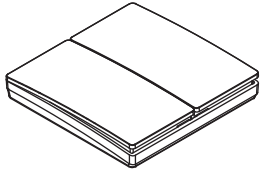

x 1

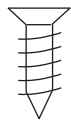

x 2



x 2

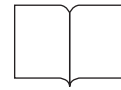

x 1

or 3 Gang:

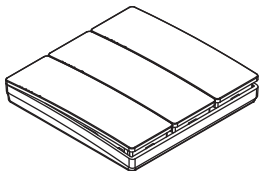

x 1

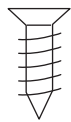

x 2



x 2

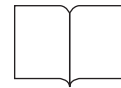

x 1

B. Specifications

Dimensions:

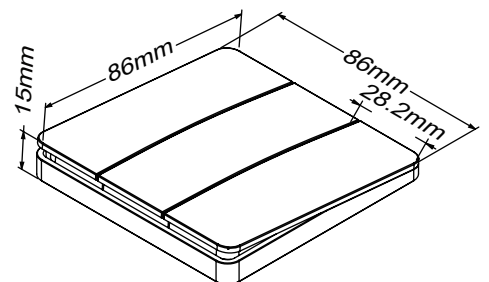
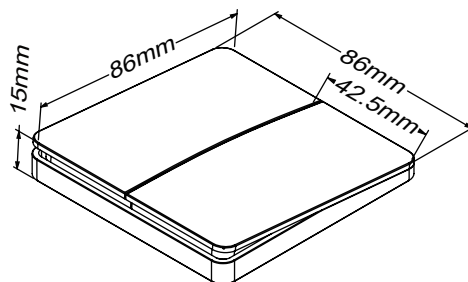
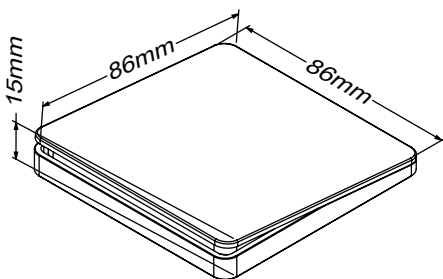

Power Source:

Self Powered (Kinetic)

Radio Frequency:

433 MHz

Switching Type:

Push Switch

Dimming Type:

Push Selected

Only available on 2 Gang Switch

IP Rating:

IP65

Body Material:

Polycarbonate

Transmission Range:

Outdoor 150m (no barrier)

Indoor 25m (plaster board; drywall)

Indoor 12m (concret, glass walls)

(Range may vary depending on surrounding situation)

UK
CA



CE RoHS



C. Installations - Suitable for Indoor Use only.

1. Screw Installation

(a) Remove front cover;

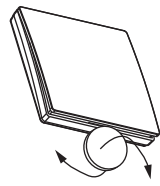
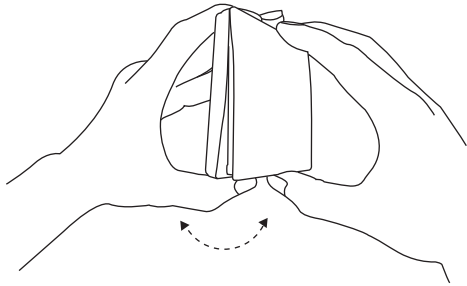

Inserting a coin into the switch gap and twisting it, can help to open the cover.

(b) Fix to back box;

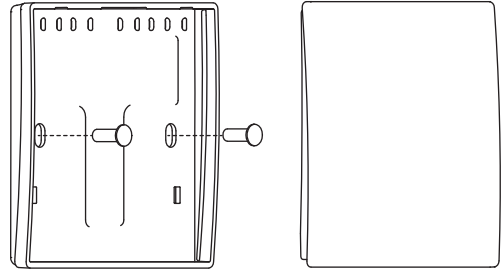

(c) Reinstall front cover;

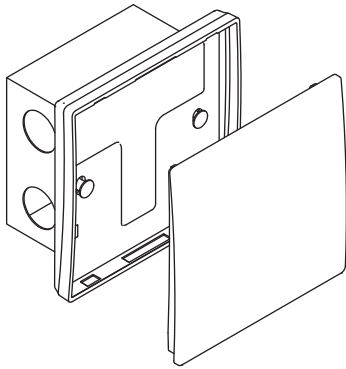

(d) Installation Completed.

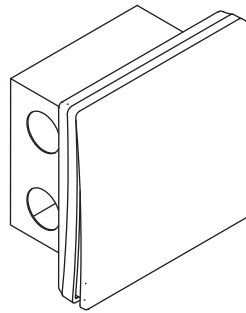

2. Surface Installation

(a) Remove sticker cover;

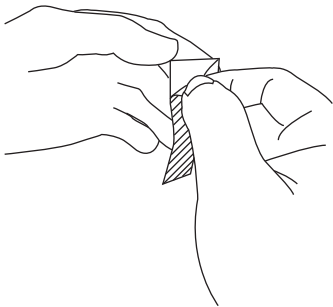

(b) Apply to the switch;

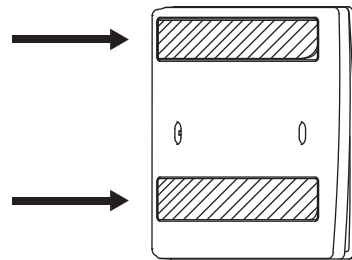

(c) Clean the surface

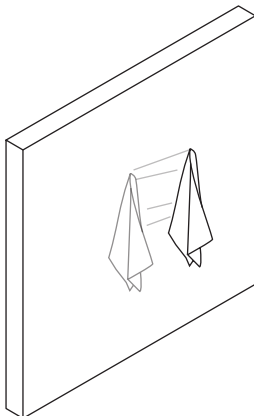

(d) Attach the switch to surface.

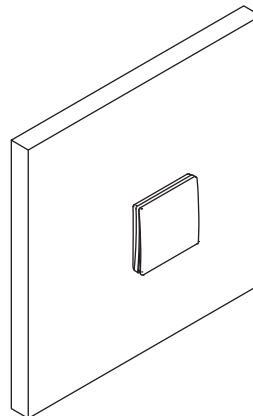

D. Operation

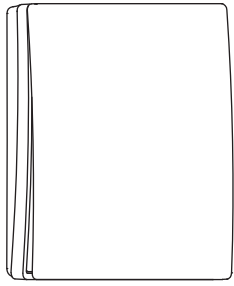

1 Gang



2 Gang



3 Gang

I/O ON / OFF Switch

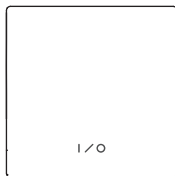

1 Zone

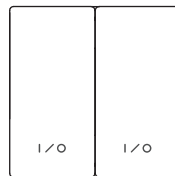

2 Zone

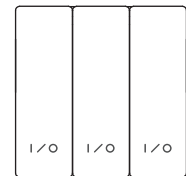

3 Zone

Dimmer Switch

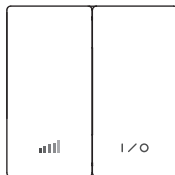

1 Zone

CCT Switch

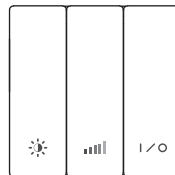

1 Zone

RGB Switch

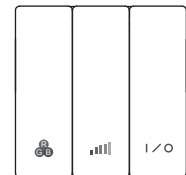

1 Zone

E. Compatible controllers (Order seperately.)

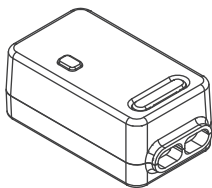

ON / OFF Receiver

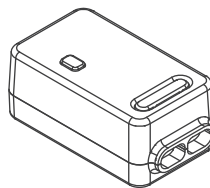

ON / OFF Receiver
Tuya Wifi (2.4G)

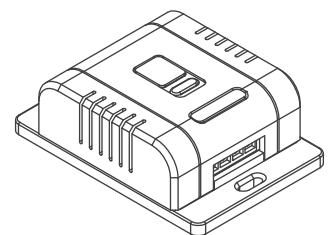

Dimmer Receiver
Tuya Wifi (2.4G)